



# EV Charging Solutions

An extensive range of electric vehicle charging solutions for domestic and commercial installations from two of the worlds leading manufacturers



 **circontrol**

 **smapppee**



## Overview of EV Charging Systems

As electric vehicle sales grow year on year, the need for EV users and owners to easily recharge their vehicles in a convenient and cost effective way becomes an important part of EV ownership.

Home, business or workplace EV chargers are not actually chargers, they are a safety and control interface for the AC voltage supplied from a building, to the EV's on-board AC to DC charger. These units are referred to as **EVSE** (Electric Vehicle Supply Equipment).

Commercial high speed DC fast chargers are directly charging the EV's battery at high d.c. power levels.

## EV Charging Configurations

### MODE 2

AC power in - control & communication

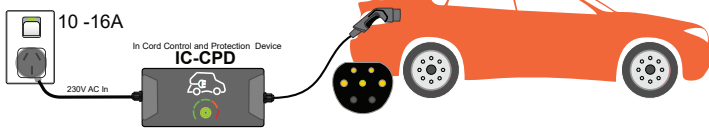

### MODE 3 3.0kW -7.4kW

Single phase AC power in - control & communication



### MODE 3 11.0kW -22.0kW

3 phase AC power in - control & communication

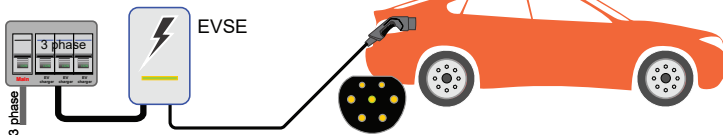

### MODE 4

DC power in - control & communication

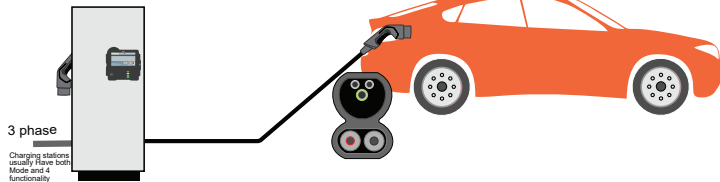

## IC-CPD - Mode 2

In Cord Control and Protections Devices (IC-CPD's) are often supplied with an EV at the time of purchase. They are sometimes referred to as trickle chargers. IC-CPD's are not EV battery chargers, they are a control and safety interface between the power socket outlet and the EV's on board charger. They are limited to less than 10A for connection into a standard 10 Amp 3 pin - flat pin socket outlet.

## Benefits of installing a smart AC charger (Mode3)

A dedicated home or business a.c. smart charger provides the safest most convenient, and by far the most cost-effective solution for keeping an EV charged and ready to go. Home or at work charging means owners are charging their EV's at the lowest per kWhr rate, and when the EV is not actually needed as part of the work day.

Issues around commercial EV chargers reliability, access and wait times are avoided when the EV is simply charged up efficiently overnight or at work during normal office hours.

## AC Type 2 plug 1 Ph 7.3 kW or 3 phase AC 22 kW

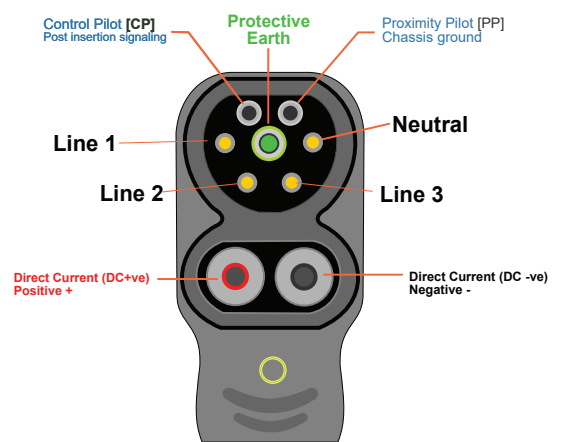
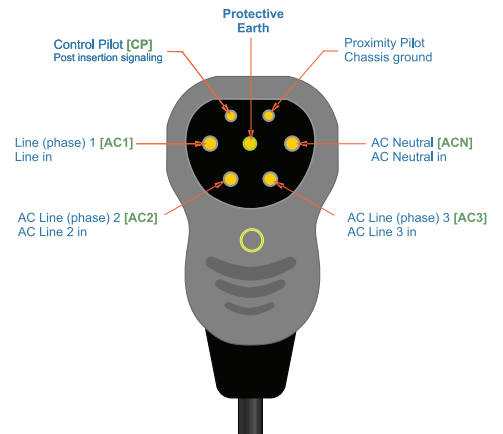

## DC type 2 CCS plug DC charging up to 400 Amps / 1000V DC

The **Control Pilot (CP)** line is used by the vehicle's On-Board Charger (OBC) and the EVSE to communicate the charging system state, the EVSE's maximum charging current and any errors. This is not an electronic data communication.

The **Proximity Pilot (PP)** line comprises a circuit designed to indicate to the OBC the type of EVSE and charging cable connected to the vehicle. A connection is made between the vehicle and EVSE by plugging a Type 2 charging cable connector into the vehicle's charging port the measured value sets the charging rate from the EVSE.

### Functions of DC fast charger (mode4)

While in charging modes 1 to 3 the alternating current is converted into direct current in the vehicle, in EV charging mode 4 the conversion from alternating current to direct current takes place in the charging station itself and not in the vehicle, so that the direct current is delivered directly to the vehicle.

Mode 4 DC chargers can range in output charging capacity from 50 to 350kW.

DC Fast charging is intended to charge the first 80% of the EV, with the last 20% being charged more slowly.

Due to their high cost and power demand, they are only used in commercial charging stations.



## Electrical Considerations for EVSE Installations

The electrical requirements for EVSE installation are not covered in the current version of the wiring rules (AS/NZS3000:2007), so additional Standards have been developed for New Zealand in the form of - **NZS PAS 6011:2021** in conjunction with the **Electric Vehicle Safety Charging Guidelines** (Worksafe NZ).

These documents are publicly available and provide safety information to EV users or those considering an EV purchase.

The Standards above refer to **EVSE - Electric Vehicle Supply Equipment**, as these units are often referred to as EV chargers. They are primarily an electricity safety and control interface from the building's power system to the EV's on board charger (OBC) and battery management system which are bespoke to that EV.

**EVSE units must be installed by an electrician holding a current NZ practicing licence.**

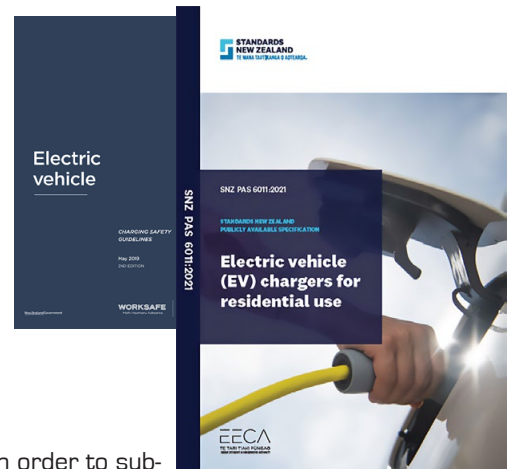

**Fig 1.** Shows the general arrangement required for the installation of a domestic or single unit commercial EVSE.

EVSE's for domestic use are limited to a maximum input power of 32 Amps a.c. In order to substantially charge an EV a considerable amount of power over an extended period maybe required (depending on level of charge and the capacity [kW rating] of the EV's battery.)

Before selecting or installing an EVSE, the building and electrical infrastructure should be assessed by a qualified electrician. The electrician will access the buildings electrical systems and provide advice on the suitability for an EVSE installation.

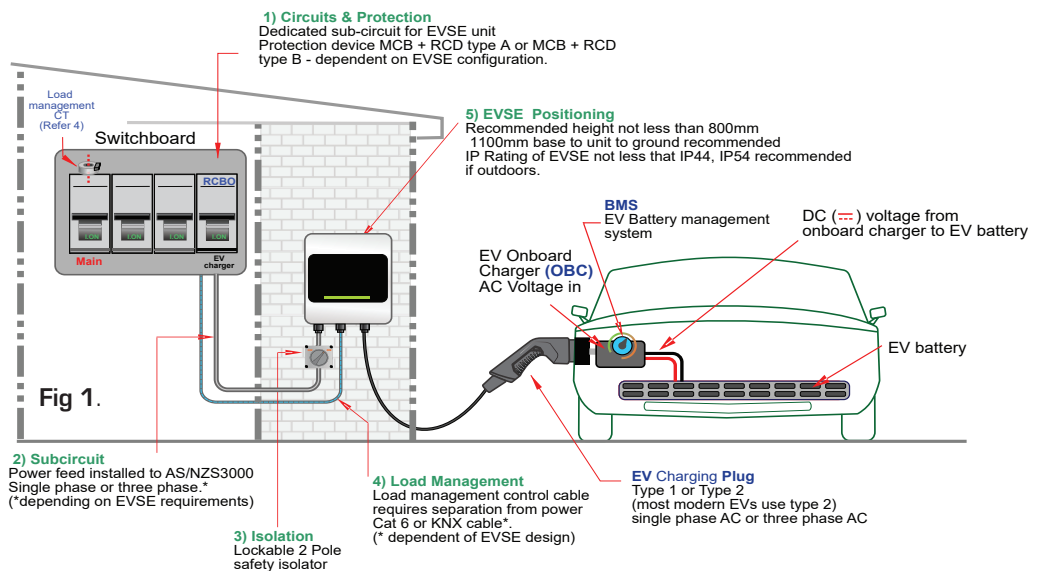

### Load management and smart EVSE's

Load management uses a small CT (current transformer) fitted at the consumer's switchboard. When connected in conjunction with the EVSE, the home or building can be protected from overloading the supply fuse and consumer mains by setting the appropriate parameters. The EV charging parameters can be set so the EV charging current is variable and relative to the homes total power load.

With smart charging, the smart phone app allows for installation setting of the maximum power limits. The EV's rate of charge is managed in conjunction with the fluctuating building demand. It also maximises the options for off-peak or special tariff rates from the consumers energy retailer.

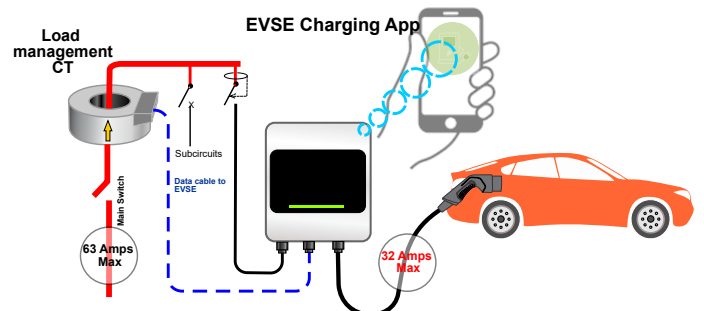

Basic arrangements for EVSE Load management

### Smappee Infinity

Smappee smart EVSE's includes all the hardware for installing dynamic load management. The Smappee Infinity system utilises a IoT cloud system with a free app for a total energy management solution. The associated mobile device app provides the functionality to control the EVSE's operation, solar integration, power monitoring, reporting, and electrical load management for the whole installation.

A separate Smappee Infinity technical guide is available on the Active Electrical Suppliers website [www.goactive.nz/brochures/smappee-infinity](http://www.goactive.nz/brochures/smappee-infinity).



# Circontrol

## Model eHome

### Domestic Mode 3 Charger

- Model code:** **T2C32** (Type 2 x 5m Charging Cable, 32A, 1Ph)  
**T1C32** (Type 1 x 5m Charging Cable, 32A, 1Ph)  
**T2C16** (Type 2, 5m Charging Cable, 16A, 3Ph)

Electrical safety protection: Built-in 6mA RDC-DD + 30mA type B RCD

### Conceptual Design

An attractive and compact design is key for home chargers to fit into your garage. The eHome was created drawing on this vision, for great durability and an easy-to-use design, while remaining affordable.

### Application

Designed to be installed at a variety of home charging settings, such as a home garage or private workplace.

### Features:

- IP54 Rating
- Type 1 or 2 plug wired in charging cable
- ABS (UV resistant) housing
- LED bar on the front panel provides users with information about the charger's status:
  - Green - Available and ready to Charge
  - Flashing blue light - Charging
  - Constant blue light - Charging complete
  - Red - Fault detection
- Built-in fault diagnostics
- Metal cable holder

### Load management control

Applicable for single phase 63A supply residential applications.

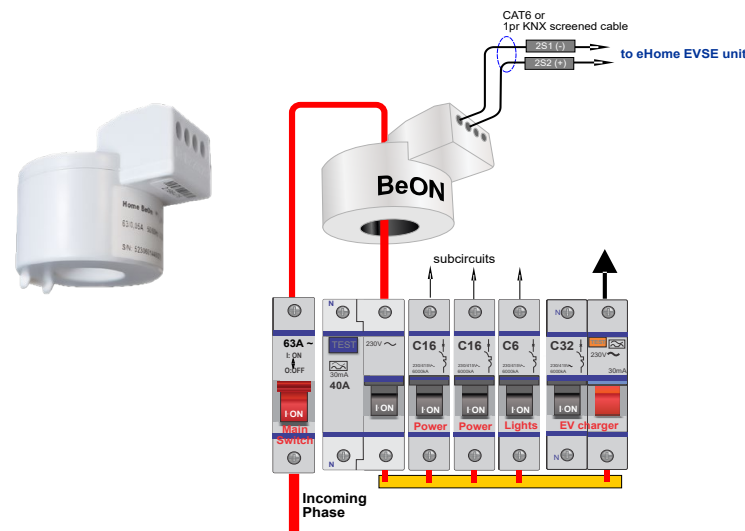

BeOn is Circontrol's load management hardware. BeON is a sensor that can be easily added to a modern switchboard to dynamically adjust the current supplied to the EVSE to the power available at any given time, thus avoiding overloading or disrupting the use of other building appliances.



The new eHome is equipped with a 6mA Residual Current Detection Device (RDC-DD) and a 30mA type B RCD under a lockable front flap. This feature allows the user to easily reset this safety device should it trip for any reason.

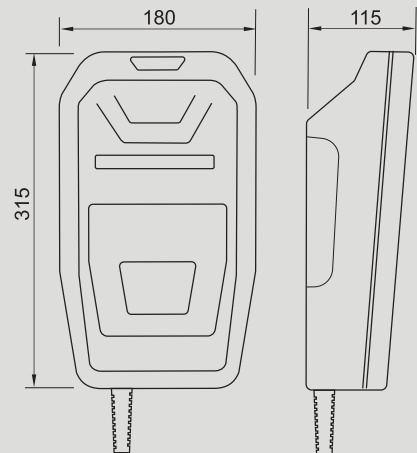

eHome is compact so it can easily fit, to be discreet in small garages or carports.



# EV Charger Selection Guide



## Residential

## Commercial Three phase

### Single phase

### Three phase

### Wall mount

### Floor mount



Circontrol eHome



Smappee EV Wall Home



Circontrol eNext Elite



Circontrol Post eVolve



Circontrol eNext Park S2



Smappee EV One Home



Smappee EV Wall Business



Smappee EV Base



Smappee EV Wall Home



Circontrol eNext Park S2  
single phase



Smappee EV One Business



Smappee EV One Home



**Basic**:- refers to a EVSE with no integration to smart phone applications.



**Smart**:- refers to a EVSE with integration to smart phone application and communications for load management controls

## ALWAYS BE CHARGING.NZ - a digital key for EVSE's

Always Be Charging is a locally designed app for Apple and Android phones that provides EVSE host or owners with the ability to easily monetise the use of their smart EV charger. The app allows adding \$/kWhr, on-charging to users, site amenity information, images of the carpark / charger and pre booking.



EV drivers can find an EV charger and its details set by the host within the app, book in advance if needed, drive to the location with built-in GPS, scan QR Code, pay securely via credit-card, and view the receipts / charging history.

The app provides stress-free charging experience for EV drivers with an in-app support line (0800CHARGING).

Remote management of the EVSE electricity load is provided for hosts or operators via CMS (Charging Management Software). The app and its CMS work with any smart EVSE using OCPP 1.6J or higher (Open Charge Point Protocol) and internet access.

Note: All models except eHome featured in this brochure are equipped with OCPP functionality.

( Visit the website [www.alwaysbecharging.nz](http://www.alwaysbecharging.nz) for full details, or call 0800CHARGING)



UNLOCK SMARTER CHARGING





# Circontrol

## Model eNext Park S2 and Elite

Model code: TBA????

Powerful intelligent EV chargers with the possibility of having connections to a cloud-based software or back end system for billing or system management.

### Application

Designed to be installed indoors or out in workplaces, apartment blocks, communal parking areas.

Capability for building owners to charge for or restrict usage to staff, or clients.

### Features:

- Single phase (Park S2) Three phase (Elite)
- 32A / phase input current
- 22kW outlet power
- Type 2 charging cables (ordered separately)
- ABS (UV resistant) housing
- RGB Led status indication on front panel
- RFID reader
- Built-in fault diagnostics
- Enclosure rating: IP54

### eNext Park S2

Electrical safety protection: Requires Type "B" RCD at main switchboard

Mode 3 single phase (up to 64A supply)

Can be configured as:

- A) Single EV charging



- B) Two EV's simultaneous charging
- Ethernet connection 10/100BaseTX (TCP-IP)
- 4G modem built-in
- 2 line LCD display for user charging information
- Open Charge Point Protocol (OCPP)
- Built-in energy meter for accurate kWhr billing

### eNext Elite additional features

Electrical safety protection: Built-in 6mA RDC-DD + 30mA type A RCCB

- Three phase electrical connection
- Backlit 3.5" LCD panel provides user guidance instructions.
- Wi-Fi connection.
- 4G modem built-in



eNext Park S2

Model code: Park-S2



eNext Elite

Model code: Elite T



eNext Park 2 and Elite shown installed on the optional aluminium powder coated pedestal (H:1500, D: 150, W: 370mm).



## Model Post eVolve (3 Phase)

Model code: **PVS00064013CC00ZG132**  
(Post eVolve Smart-T, 2 x Type 2 Sockets, 3Ph)

Electrical safety protection: Two built-in RCD's Type B 30mA RCD protection.

## Application

Designed to be installed in both public access environments e.g. urban spaces, shopping centres, car parks, airports, petrol stations, and private areas where it's intelligent capabilities offer a range of possibilities which improve the user and operator experience.

## Features:

- Up to 3 phase 44kW of charging power
- Shuttered socket outlets for two type 2 charging plugs
- Two built-in MID power meters
- Communication, Ethernet port (by default)
- Embedded load management network integration
- Enclosure rating - IP54
- Robust aluminium & ABS case
- Front door lock with key (operator access)
- Interface protocol: OCPP1.6
- Charging leads (type 2) are ordered separately
- Optional 4G modem
- Option with front panel logo's for advertising

## Charge point operations

Communication, either by its Ethernet port (by default) or 4G modem (optional). The charger can be connected to a back-office system (by means of OCPP) obtaining benefits such as user management, billing, remote error diagnostics etc.

To comply with the most demanding requirements regarding billing, eVolve series includes a MID certified meter on each outlet.

Post eVolve offers a flexible authentication, meaning the user can either authenticate before or after connecting the cable to the EV. Additionally, the authentication process can also be disabled for a 'plug & charge' use mode.



Post eVolve



### User Interface

Clear charging instructions and plug status are shown using a back-light display, increasing user satisfaction, especially useful when the charger has been previously reserved by another user.

Dual LED's provide EVSE operational status.



## Smappee EV Wall Home

Model:

EVW-132-BSR-E-W-100A (EV Wall Home, Type 2 Socket, 1Ph)

EVW-132-C8R-E-W-100A (EV Wall Home, Type 2 with 8m Cable, 1Ph)

EVW-332-BSR-E-W-100A (EV Wall Home, Type 2 Socket, 3Ph)

EVW-332-C8R-E-W-100A (EV Wall Home, Type 2 with 8m Cable, 3Ph)

Electrical safety protection: Built-in 6mA RDC-DD + 30mA type A RCD protection.

The Smappee EV Wall Home EVSE provides a stylish and very functional solution for EV charging in homes. It can be easily optimised for off-peak charging and where the home has a solar PV system.

The Smappee EV Wall Home is quick to install with a simple cable configuration and installation wizard. There are options available for single-phase or three phase homes.

### Features:

- Awarded No1 by Clean Energy Reviews for best smart EVSE.
- Free smart phone smart charging App
- Swipe card or App authorisation for multi-user or user-pay applications. (one swipe card included)
- Single phase 7.4 kW (32 amps max) output or
- Three phase up to 22 kW 32A/phase output
- Built-in kWh meter compliant with IEC 62053-21
- Built-in WiFi & Ethernet Capability"
- Supplied with type two tethered 8 mtr cable and holder or Type 2 socket
- IP54 rated, powder coated metal & aluminium enclosure
- 36 Month warranty
- Includes Smappee Infinity fittings for load management.

### Intelligent Load management with Smappee Infinity

What makes the Smappee EV charging systems such exceptional value is the included integrated energy management hardware and control system.

The Smappee EV Wall Home comes complete with the hardware to install at the main switchboard, so the system can monitor and limit the maximum power demand on the consumers electrical systems. With this, there is no risk of overloading the building fuses or power supply. Although this may sound complicated, for any building with a modern switchboard it is a simple task for the installing electrician.

The infinity Load management system integrates seamlessly with the smart phone App or the Smappee PC home dashboard to provide a total energy management solution.



Plug and charge



Swipe and charge



Scan and charge

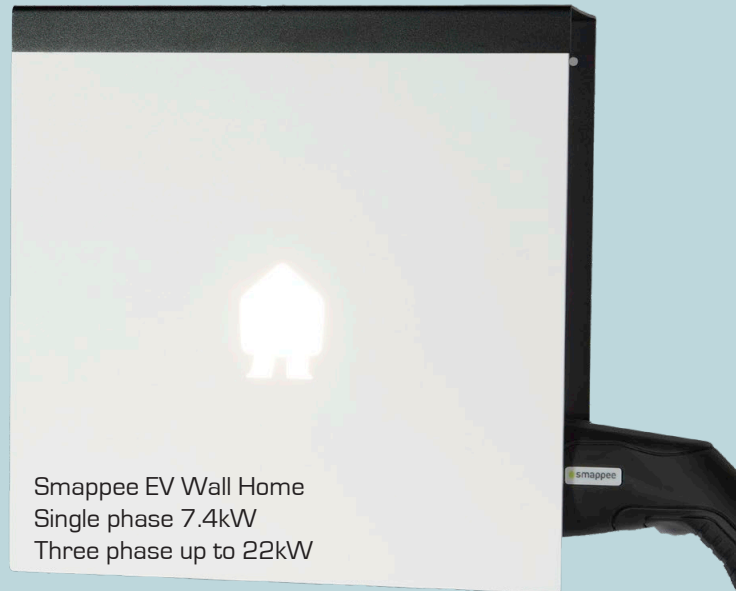

Smappee EV Wall Home  
Single phase 7.4kW  
Three phase up to 22kW

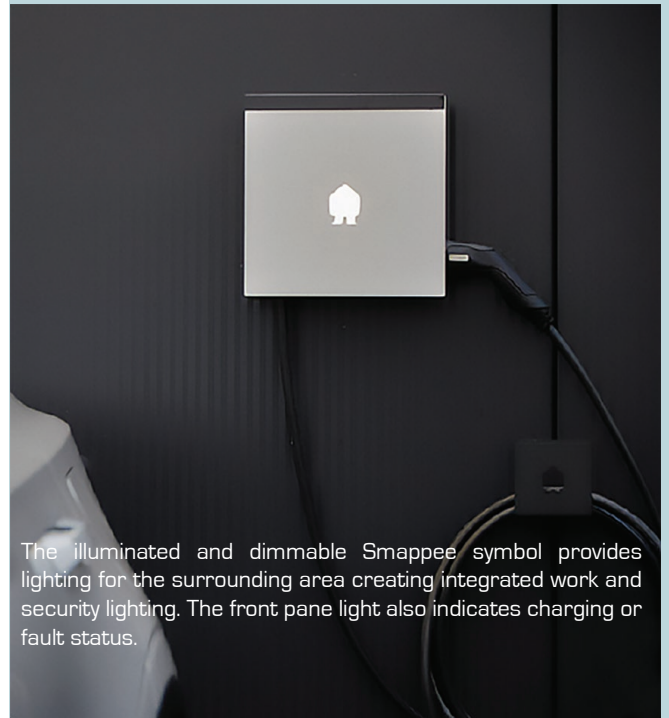

The illuminated and dimmable Smappee symbol provides lighting for the surrounding area creating integrated work and security lighting. The front pane light also indicates charging or fault status.



Manage charging sessions from anywhere with your smart phone.

The Smappee App allows the user to easily control charging times, and schedules to optimise the available power and tariff rates. The App also provides monitoring of the vehicles charge status, along with unique options for power usage and control, system status, and charging data reporting.





## Smappee EV Wall Business

Model Codes:

EVWB-332-BSR-E-W (EV Wall Business, Type 2 Socket, 3Ph)

EVWB-332-C8R-E-W (EV Wall Business, Type 2 with 8m Cable, 3Ph)

Electrical safety protection: Built-in 6mA RDC-DD + 30mA type A RCD protection.

The Smappee EV Wall Business 22kW three phase electric vehicle charger provides an award winning design aesthetic for any business or commercial property. Equipped with extensive range of options for business to provide a viable charging facility for staff or customers.

The Smappee EV Wall Business works with single-phase 240V AC (7.4kW) or three phase 400V AC (22kW) output.

- Integrated safety feature RDC-DD +RCD protection
- IP54 rated, powder coated metal & aluminium enclosure
- 36 Month warranty

### The EVSE can be ordered with option:

(a) Type 2 socket on the wall unit, this allows the lead to be removed for security.

(b) Supplied with an 8m lead with type 2 plug, which is wired directly into the wall unit.

The Smappee EV Wall Business installed with a cable configuration and installation wizard. The integrated LED lighting indicates charging status and provides (programmable) ambient lighting when not in use.

### Integrated payment options

Being OCPP 1.6 J compliant, the Smappee EV Wall Business can be configured to operate with a third party billing platform. Charging sessions can be started and stopped via plug & charge, RFID, smart charging schedules, and QR code for CPO services.



**Plug and charge** - Plug the EV into the Smappee EV Wall Business to start charging, and unplug it to stop charging.



**Swipe and charge** - Plug in, swipe an RFID card in front of the LED lights and start charging. And for added safety: the charging station unlocks only after the card is swiped. Charging can also be controlled in the App.



**Scan and charge** - Scan the QR code on the Smappee EV Wall Business to connect and charge vehicles. Charging can also be controlled via the App.

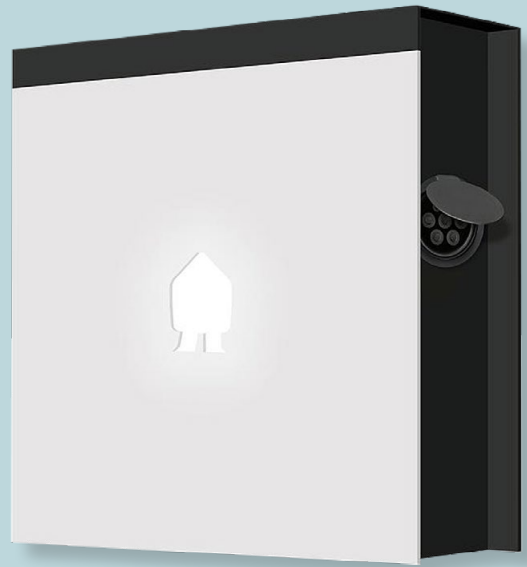

Smappee EV Wall Business  
Single or three phase power up to 22kW



### Smappee intelligent load management

With optional Smappee Infinity kit, EV Wall Business can be integrated for complete energy management of the building's load demand".

Dynamic Load Balancing - Adjusts the output across all chargers to protect from circuit overload or an excess maximum demand power loading.

Smart EV Charging - The smart charging function prioritises the use of excess solar power during the day and off-peak rates overnight or on weekends. The output of the charger can even be controlled such that only excess solar power is used for charging.



# smappee

## Smappee EV One

### Model Codes:

**EV One Home: Model Code: EVO-332-B-E-B**

**EV One Business : Model Code: EVOB-332-B-E-B**

Electrical safety protection: Built-in 6mA RDC-DD + 30mA type A RCD protection.

The Smappee EV One home or business is a ground mounted bollard style electric vehicle charger. It provides a contemporary minimalist design aesthetic that is unobtrusive, but fully featured, and suitable for any home or business location.

“The Smappee EV One Business has the same features as the EV One Home, but with built-in charge point functionality.

- Construction: Powder coated aluminium (black)
- Dimensions: (mm) H,1100, W,120, D, 120
- Weight :11kg, IP54
- 36 Month warranty

### Features:

The Smappee EV One Home

- Award winning minimalist design with full metal body, and base mounting plates included.
- Works with single phase (7.4kW) & three phase (22kW)
- Includes the Smappee Infinity energy management system (requires a CAT 6 communication cable along with the power supply cable for Infinity energy management.)
- Overload protection with dynamic load balancing
- Integrated charging status LED with ambient lighting when not in use
- Operation or error status indication through flashing and colour LED indication
- Manage charging sessions from anywhere with your smart phone
- Built-in RFID Reader, Wi-Fi, Ethernet,

The Smappee EV One Business 3 ph 22kW

Additional features:

- Smappee Infinity energy management system is an optional extra for EV One Business due to the wide range of energy control options available.
- Integrated MID-meter (kWhr meter compliant with IEC 62053-21)
- Integrates with public billing services via OCPP 1.6J such as “Always Be Charging.NZ”.



Plug and charge



Swipe and charge



Scan and charge

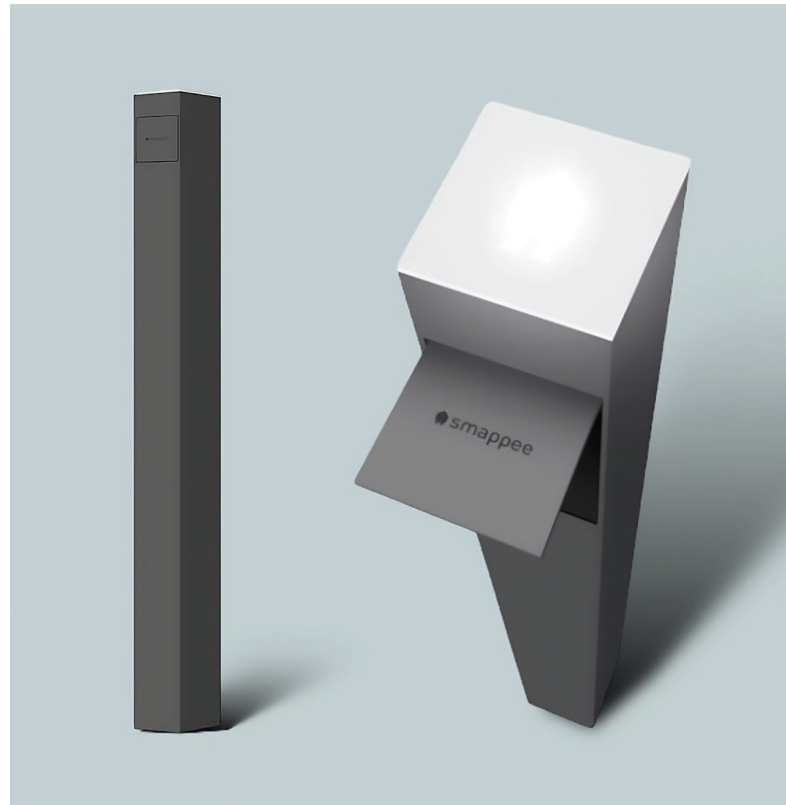

Smappee EV One Home or Business bollard style EV charger. Single phase 7.4 kW or three phase power up to 22kW



The galvanised steel in ground mounting base is included and packed into the EV One unit.



## Smappee EV Base

Model code  
EVB-2332-BS-E

Electrical safety protection: Built-in 6mA RDC-DD + 2 x 30mA type A RCD protection.

“The Smappee EV Base is a commercial EVSE that provides an award winning minimalistic design that adds to the aesthetic design of the associated building. It also provides charging for two vehicles simultaneously at 22kW output”.

With integrated MID (Measuring Instruments Directive) power meters this unit can monitor charging consumption and provides detailed consumption and charging session data via the Smappee smart phone App and online dashboard.

### The EVSE can be ordered with optional type 2 cables:

Type 2 socket on the EV base allows for the leads to be removed for security. Leads of 5,7,10 metres can be ordered separately.

Smappee EV Base, three phase - 2 x 22 kW socket with shutter, also available with 2 x 22kW, 5m tethered cable.

The Smappee EV Base electric vehicle chargers can be monitored and controlled using the Smappee online dashboard and smart phone App.

- Keep track of one, or many chargers, even across multiple locations.
- Control the state and output of chargers from anywhere with internet access.
- White-list RFID cards for security and session tracking
- Report on charging session consumption and download data to a spreadsheet for manual billing.
- Smappee monitoring & control ecosystem, add site monitoring to your charging location and enable overload protection and dynamic load balancing.

### Integrated payment options



Plug and charge

Swipe and charge

scan and charge

A separate Smappee Infinity technical guide is available on the Active Electrical Suppliers website [www.goactive.nz/brochures/smappee-infinity](http://www.goactive.nz/brochures/smappee-infinity).



Smappee EV Base mount three phase - 2 x 22 kW socket with shutter.

The integrated LED lighting indicates charging status and provides ambient security lighting when not in use.



Smappee EV Base can be configured to varying degree of output based on the power supply input such as:

2 X 7.4 kW 230V 32 A 1Ph charging outlets (right and left)

2 X 11kW 400V 16A 3Ph charging outlets (right and left)

2x 22kW 400 V 3 Ph charging outlets (right and left)

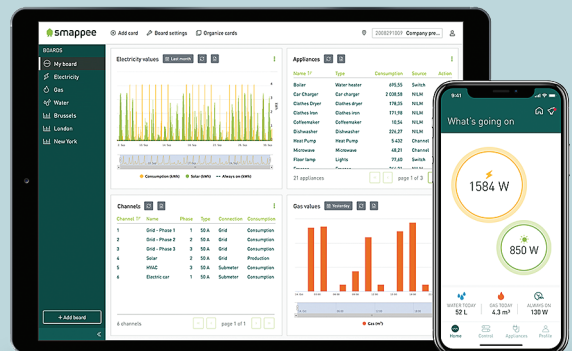

Smappee EV Base has built-in MID power meter and Smappee Infinity that provides the operator with an easy to use dashboard to control, manage and report EV charging operations and costs.





**Warkworth**  
51 Woodcocks Rd Warkworth  
Ph: 09 777 4050  
email: warkworth@goactive.nz  
Branch mgr: Rhys Green

**Auckland**  
14c Tawa Drive Albany  
Ph: 09 909 0490  
Email: Albany@goactive.nz  
Branch mgr: Daryl Mudford

32 Normandy Rd Mt Eden  
Ph: 09 903 0630  
email: mteden@goactive.nz  
Branch mgr: Gerald Hargreaves

27 O'Rorke Rd Penrose  
Ph: 09 5557740  
Email: penrose@goactive.nz  
Branch mgr: Phillip Brown

17 Nandaina Ave East Tamaki  
Ph: 09 399 8065  
Email: Easttamaki@goactive.nz  
Branch mgr: Tracey Eaton

10 Norman Spencer Dr Manukau  
Ph: 09 970 8940  
Email: Manukau@goactive.nz  
Branch mgr: Andrew Davis

271 Gt South Rd Drury  
Ph: 09 869 3316  
Email: Drury@goactive.nz  
Branch mgr: Mike Heraud

**Nelson**  
8 Washington Rd Nelson  
Ph: 03 970 2198  
email: Nelson@goactive.nz  
Branch mgr: Natasha Howe

**Whangarei**  
41 Commerce St Whangarei  
Ph 09 699 3050  
email whangarei@goactive.nz  
Branch mgr: Aaron Furze

**Hamilton-Waikato**  
45 Bryant Road Te Rapa  
Ph: 07 9034030  
email: Terapa@goactive.nz  
Branch mgr: Mark Scantlebury

61 King St Hamilton  
Ph: 07 9034030  
Email: penrose@goactive.nz  
Branch mgr: Luke Scantlebury

494 Slone St Te Awamutu  
Ph: 07 777 8016  
email: Teawamutu@goactive.nz  
Branch mgr: Shirley Fitzgerald

8 Seddon St Te Kuiti  
(Satellite branch)  
Branch mgr: Shirley Fitzgerald

**New Plymouth**  
106 Gill St New Plymouth  
Ph: 06 215 4246  
email: newplymouth@goactive.nz  
Branch mgr: Gary Jackson

123 Glover Rd Hawera  
(Satellite branch)  
027 922 8878  
email: hawera@goactive.nz  
Branch mgr: Malcolm Yates

**Palmerston Nth**  
667 Tremaine Ave Palmerston Nth  
Ph: 06 399 7051  
email: palmerston@goactive.nz  
Branch mgr: Hayden Denby

**Hawkes Bay**  
209 Ellison Rd Hastings  
Ph: 06 975 4020  
Email: Hastings@goactive.nz  
Branch mgr: Bryce Gilbert

**Bay of Plenty-Taupo**  
39 Waihi Rd Tauranga  
Ph: 07 777 0122  
email: tauranga@goactive.nz  
Branch mgr: Tim Whitehead

75 Newton St Mt Maunganui  
Ph: 07 777 0378  
email: mtmaunganui@goactive.nz  
Branch mgr: Michelle Gillgren

6/11 Ashley Place Papamoa  
(Satellite branch)  
email: papamoa@goactive.nz  
Branch mgr: Michelle Gillgren

9 Giltrap St Rotorua  
Ph: 07 399 4050  
email: rotorua@goactive.nz  
Branch mgr: Wesley Larey

2/4 Mahoe St Taupo  
Ph: 021 908 723  
email: taupo@goactive.nz  
Branch mgr: Aaron Reid

**Blenheim**  
12 Stuart St Blenheim  
Ph: 03 578 3717  
email: Blenheim@goactive.nz  
Branch mgr: Mike Van Dijk

**Christchurch**  
568 Wairakei Rd Papanui  
Ph: 03 943 5359  
email: papanui@goactive.nz  
Branch mgr: Rod McDonald

119 Montreal St  
Ph: 03 379 1667  
email: christchurch@goactive.nz  
Branch mgr: Nicholas Boltar

43 Hickory Place Hornby  
Ph: 03 741 1302  
email: hornby@goactive.nz  
Branch mgr: Tyler Hart

**Wellington**  
152 Hutt Rd Petone  
Ph: 04 5550758  
Email: petone@goactive.nz  
Branch mgr: Philip Watson

**Timaru**  
17 Bank St Timaru  
Ph: 03 956 5020  
email: Timaru@goactive.nz  
Branch mgr: Graeme Russ

**Active Electrical Suppliers Ltd**  
29 branches nationwide  
go to: [www.goactive.nz/branches](http://www.goactive.nz/branches) to find your local branch details



**active**  
ELECTRICAL SUPPLIERS LTD



Active Electrical Suppliers  
Support Office  
27 O'Rorke Rd Penrose Auckland  
Ph: 09 5557741  
email: admin@goactive.nz  
[www.goactive.nz](http://www.goactive.nz)